

433 MHz



Non-compliance with the specification might cause risk for life or health and can determine proper work of the blind.

We strongly recommend to comply with the specification.

Installation of the tubular motor should be performed by specialists with 1kV or higher SEP-certified electrician's licence (SEP - Association of Polish Electrical Engineers) or equal license.

1. General information



EVY motors are motors with radio receiver. They have a mechanism for detection of obstacles, so that the motor stops if sensing resistance in its path. Detection of obstacles works in both directions, with the use of security locks as well as with springy hangers. Electronic limit position switches set by using the remote control provide ease of programming. Motors provide the ability to set the third position. For EVY motors, it is possible to connect an impulse switch that controls the motor in "step by step" mode. EVY series tubular motors are compatible with all YOODA brand devices.

1. Radio receiver memory:
up to 20 transmitters

2. Max time of continuous work:
4 min.

3. Power supply:
230 V / 50 Hz

4. Operating temperature:
from -5°C to 50°C

5. Protection degree:
IP 44

Illustrations from the top:

1. Tubular motor 35 EVY with obstacle detection
2. Tubular motor 45 EVY with obstacle detection

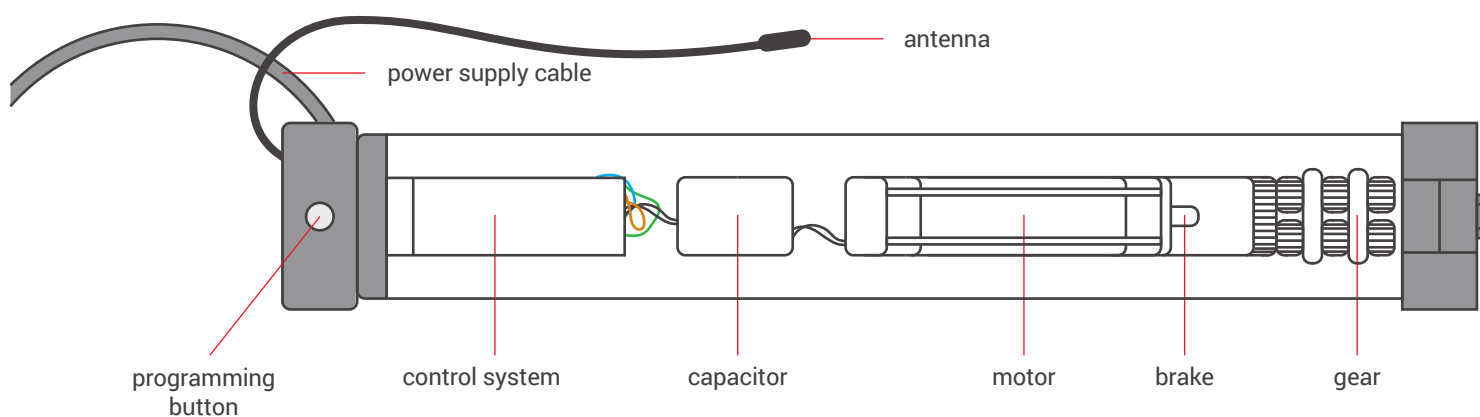

Maximal time of continuous work is 4 minutes. After that time thermal protection will be activated preventing motor from overheating. After that motor will be disabled for about 20 minutes until it cools down.

2. Safety measures

Before installing or using motor please read the following instruction. The installer must comply with the standards and regulations in force in the country where the appliance will be installed and provide information to users about the conditions and maintenance of the device. Failure to follow these instructions can present risk to life and health, or invalid functioning of the roller shutter. This also results in the loss of warranty rights.



Motors torque parameter should be adequate to the weight of the roller shutter curtain.



Wiring should be mounted in a way preventing water from entering the tubular motor, as well as for moving roller shutter curtain to make any damage.



Electrical system control should be performed regularly to detect any signs of use or damage of the motor.



Electrical supply needs to be disconnected before conducting any maintenance, cleaning and/or repair work.



All contact of the motor with any liquids should be reduced to minimum.



No tools should be used when placing motor in the tube.



During the adapter montage special attention must be paid not to damage the motor.



Motor and its control system should be kept out of children reach.

3. Placing motor in the tube



Motor should be mounted in places protected from unfavourable weather conditions.

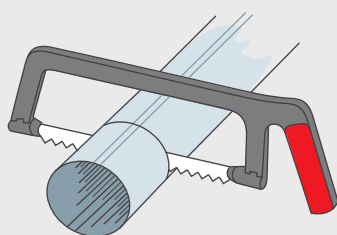

1. Cut the tube to the proper length.

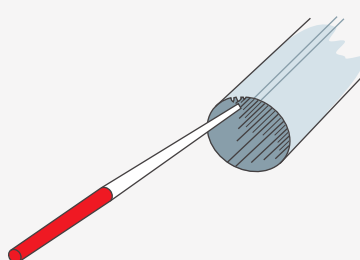

2. Deburr the edges and remove the metal residue.

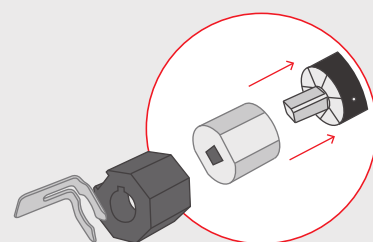

3. Place the adaptation on the motor.

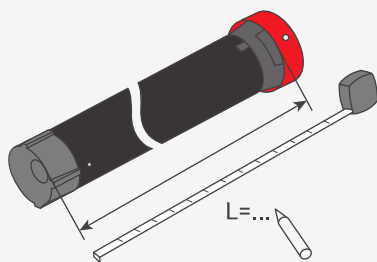

4. Measure the distance (L) between the inner edge of motors head and the end of the motors adaptor.

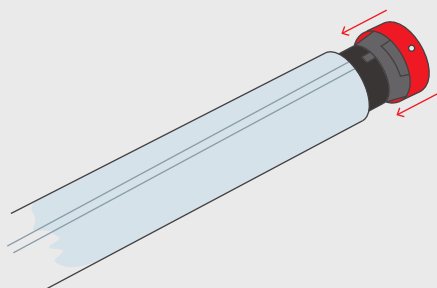

5. Insert the motor into the tube up to the point of connection between the edge of the tube and the inner edge of the motors head.

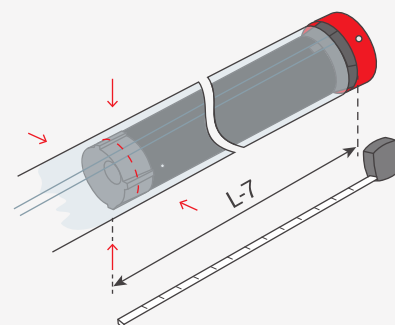

6. Secure the tube to the coupling part of the adaptation using 4 screws or rivets, placed at L-7 mm distance from the inner edge of the motors head.

4. Connection



The control of the impulse switch is possible after programming the transmitter. If the switch is not connected, protect the wires against an accidental short circuit.

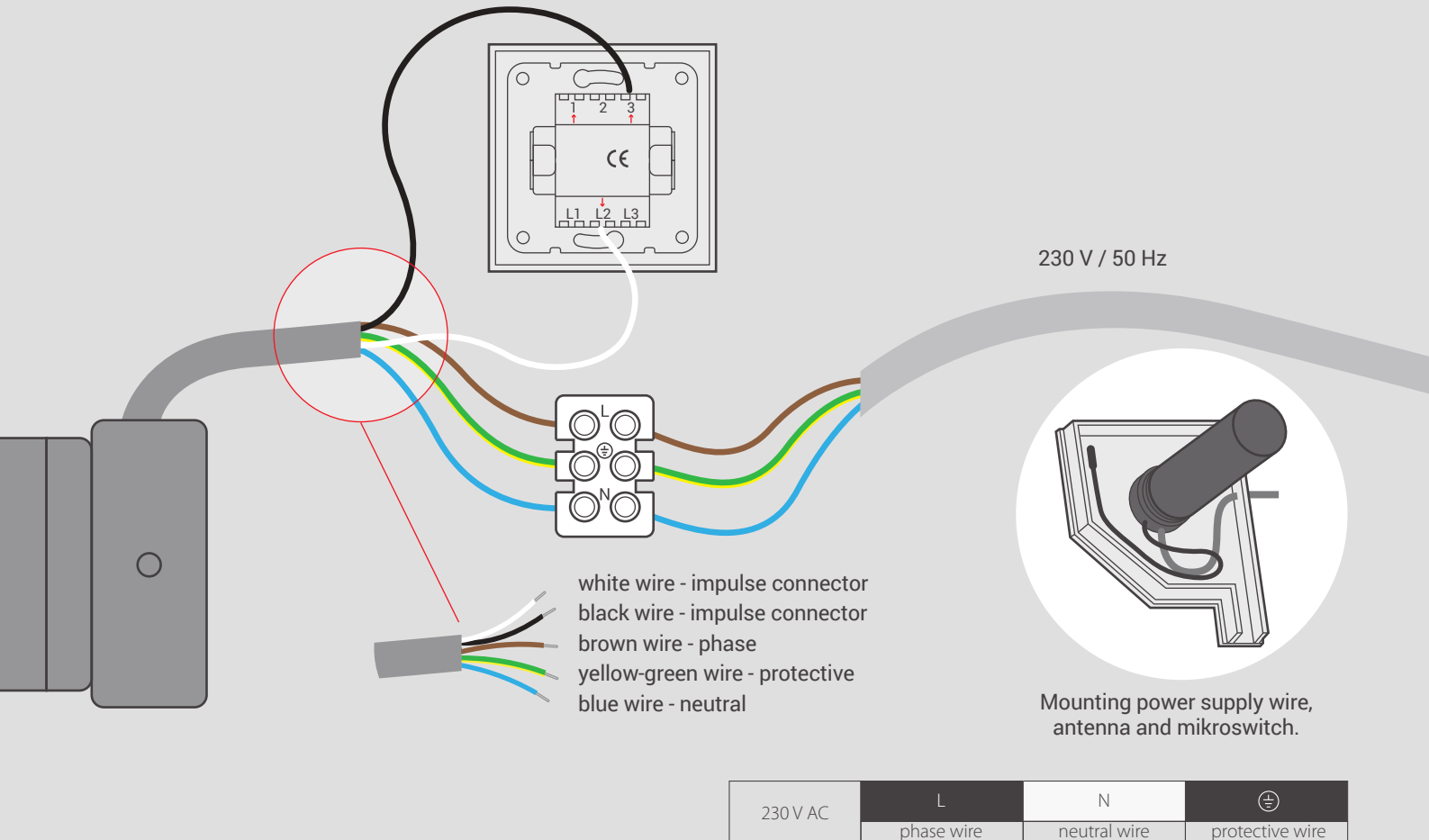

Installation of the tubular motor should be performed by specialists with 1kV or higher SEP-certified electrician's licence (SEP - Association of Polish Electrical Engineers) or equal license. Device is designed to operate in places shielded from unfavourable weather conditions. Motor should be installed in accordance with all provisions of regional law and professional standards. All cables connecting power receiver with electric source should be protected from overload and short-circuits effects with devices automatically disconnecting power. Device should be powered with a separate source and protected only with a fast-blow fuse (never slow-blow fuse). Creating electrical system using inadequate fuse may result in losing rights under the provisions of warranty. When connecting device to power source with cables with adequate cross-section should be used. Long-lasting output load capacity table should be the ground for choosing adequate cable

5. Range



Radio receiver range is a variable value and can differ from declared values depending on conditions in which device operates. Possible sources of changes in range are building construction, interference caused by other radio transmitters etc.

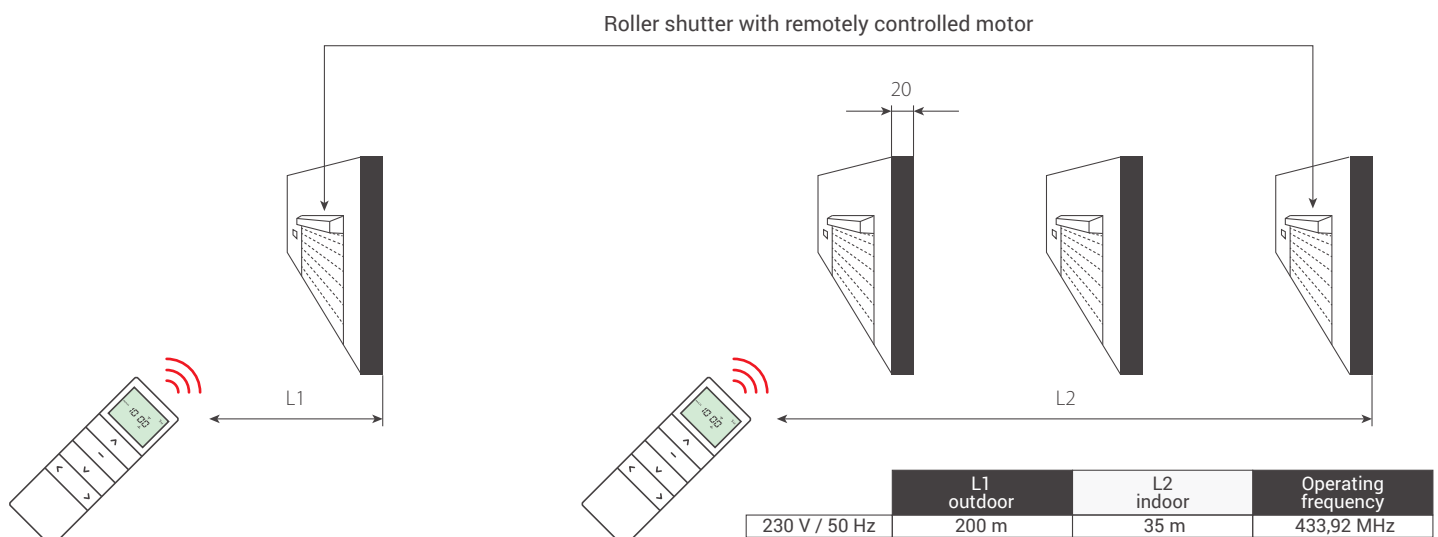

6. Programming first transmitter



1. Longer than 4 seconds pause between series of button clicks during programming will cause device to switch off from programming mode without saving any changes.
2. Programming the first transmitter removes the previously programmed transmitters from memory.
3. After turning on the power, when a transmitter is programmed in the motor's memory, the motor will emit three sounds and make a short up / down movement. Otherwise, the motor will only emit three sounds.
4. After pressing the programming button on the head of the motor, when a transmitter is programmed in the motor's memory, the motor will make a short up / down movement. Otherwise, the drive will only make one sound.

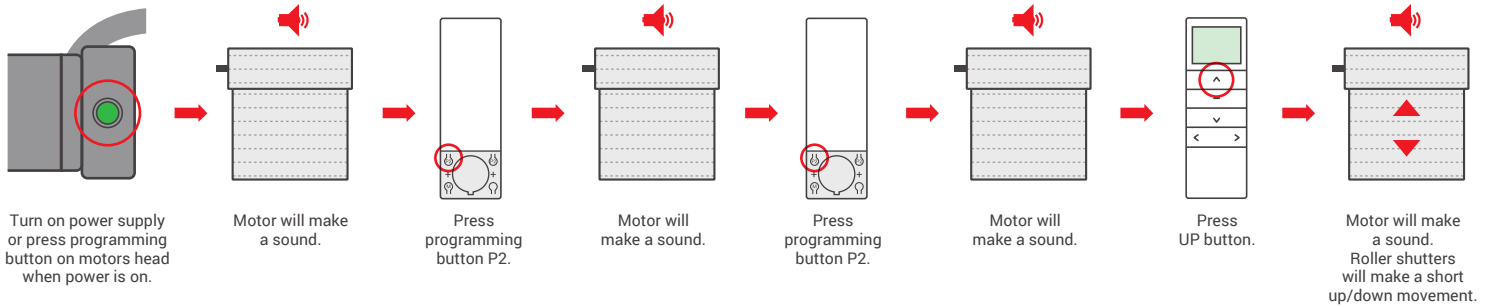

7. Changing motors direction

METHOD 1:

Changing the work motor direction removes the previously programmed transmitters from the memory.

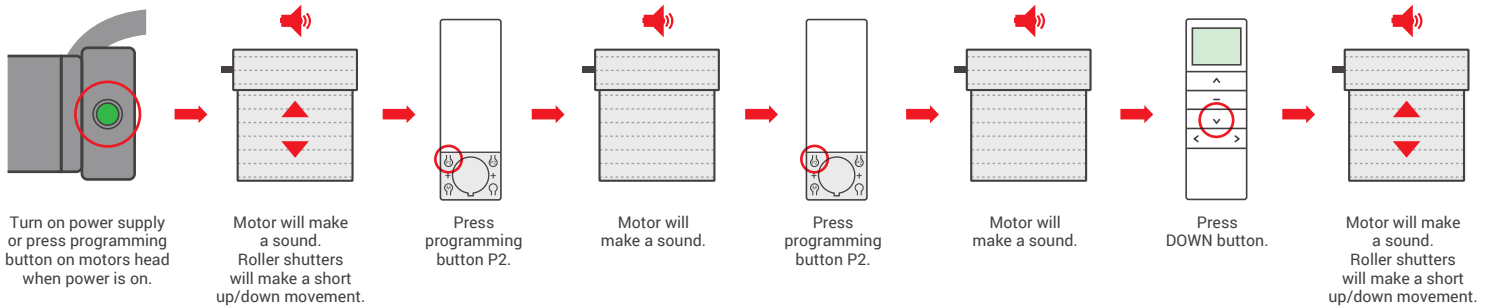

METHOD 2:

Changing the work motor direction does not change the limit positions.

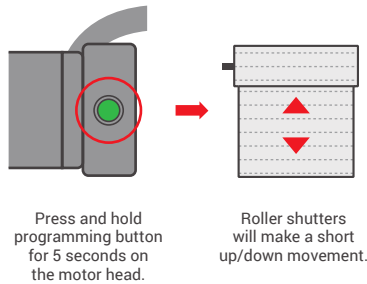

8. Programming limit positions



1. Longer than 4 seconds pause between series of button clicks will cause device to switch off from programming mode without saving any changes.

AUTOMATIC PROGRAMMING OF THE LIMIT POSITIONS:

To use the automatic programming of the limit positions, it is necessary to use elements that inhibit the bottom slat. 35EVY and 45EVY 10 Nm and 20 Nm motors have function automatic programming of the limit positions.

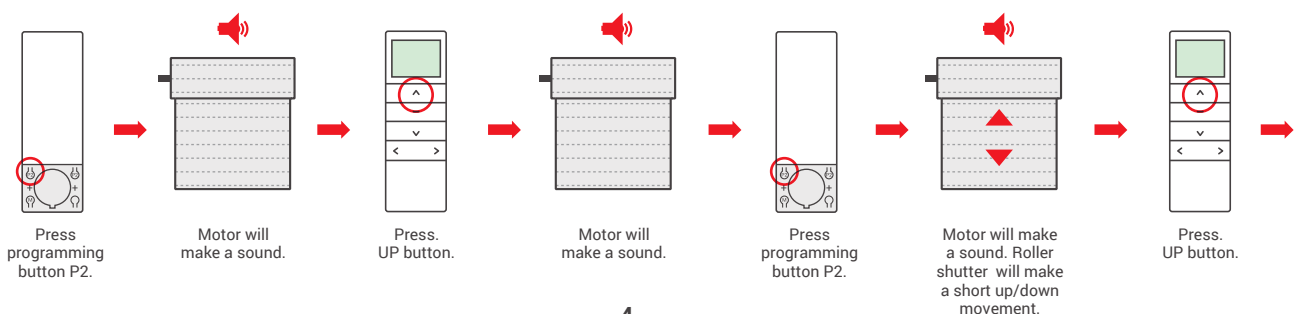



Roller shutter will stop when it feel resistance. The upper limit position will be set from 1 cm to 3 cm below this position . Then the motor will move in the opposite direction.

When the roller shutter reaches the lower limit position and feel resistance, the motor will stop and move in the opposite direction.

The motor will stop in the upper limit position, confirming the programming of the limit positions.

MANUAL PROGRAMMING OF THE LIMIT POSITIONS:

To set the upper and lower limit position press the programming button P2 during the motor movement, it causes the work displacement. Then you can precisely set the limit positions. Pressing the P2 button again motor will run continuously.

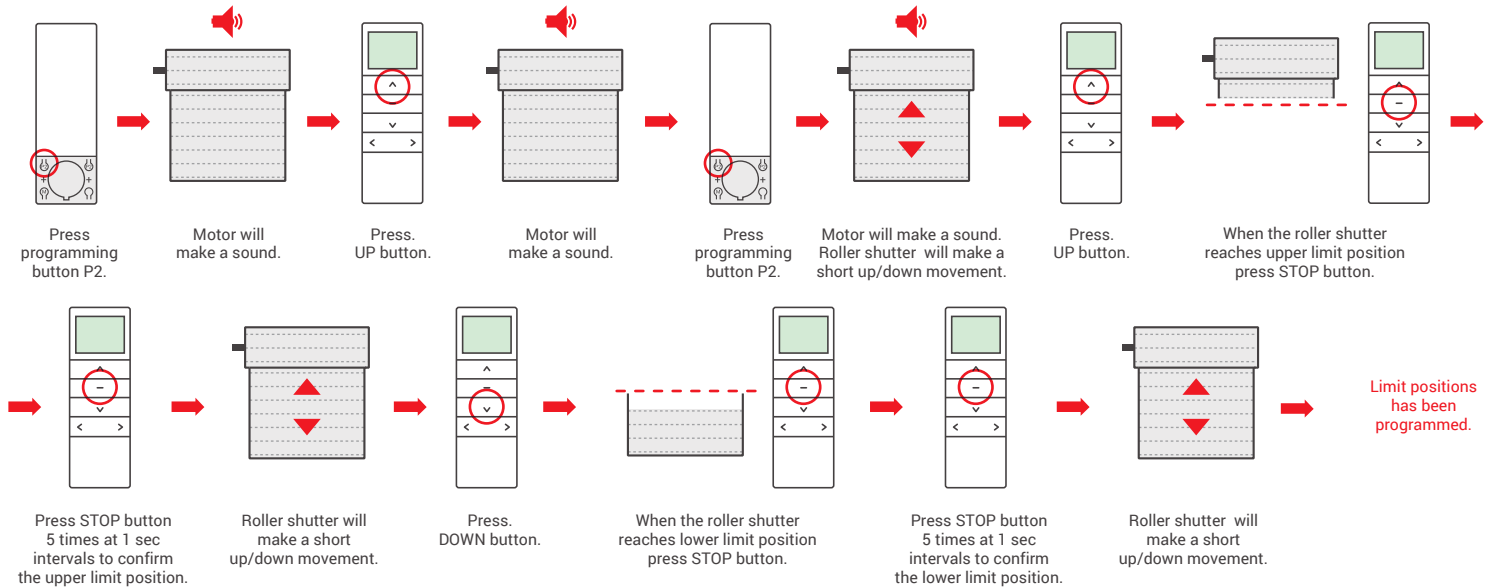

9. Automatic regulation of the limit positions



1. When this function is activated, the limit positions are automatically adjusted every 30 days after the motor is started up or down.
2. 35EVY and 45EVY 10 Nm and 20 Nm motors have function automatic regulation of the limit positions.
3. During the update of the limit positions, pressing the STOP button removes the limit positions.
4. To use the automatic regulation of the limit positions, it is necessary to use elements that inhibit the bottom slat.
5. This function is factory disabled.

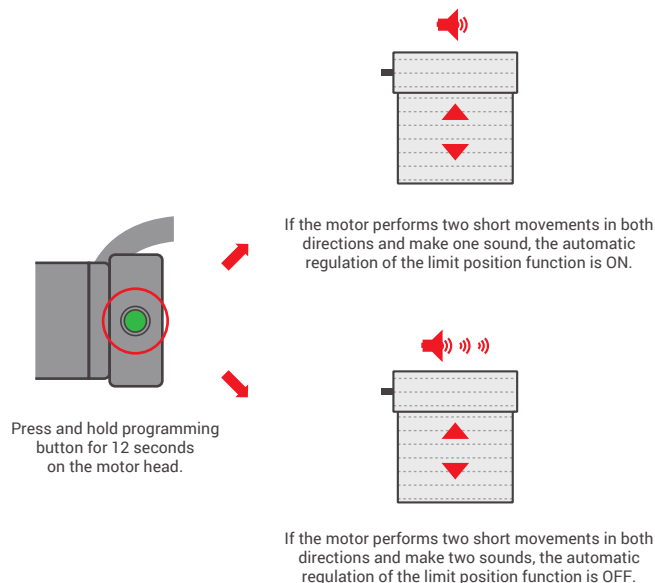

10. Programming the third limit position



1. After setting the upper and lower limit positions, it is possible to set the third position (favorite) between those positions.
2. Hold the STOP button for 3 seconds to set the blind in third limit position.

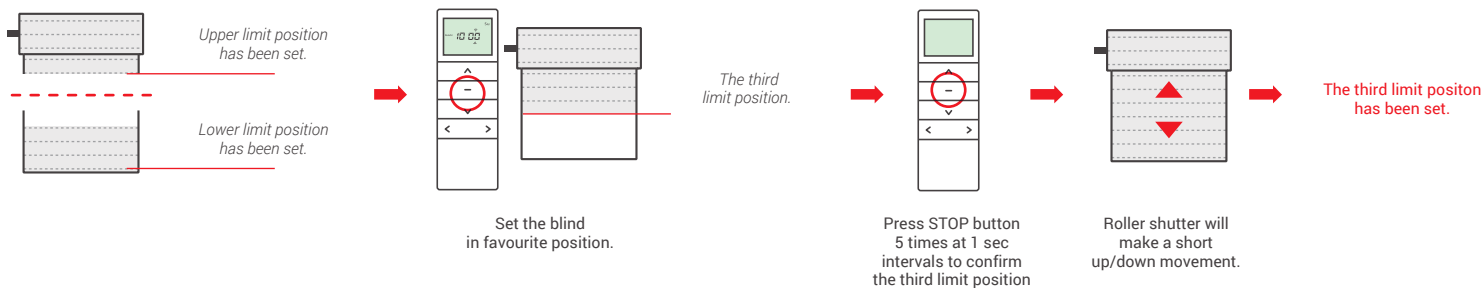

11. Removing third limit position

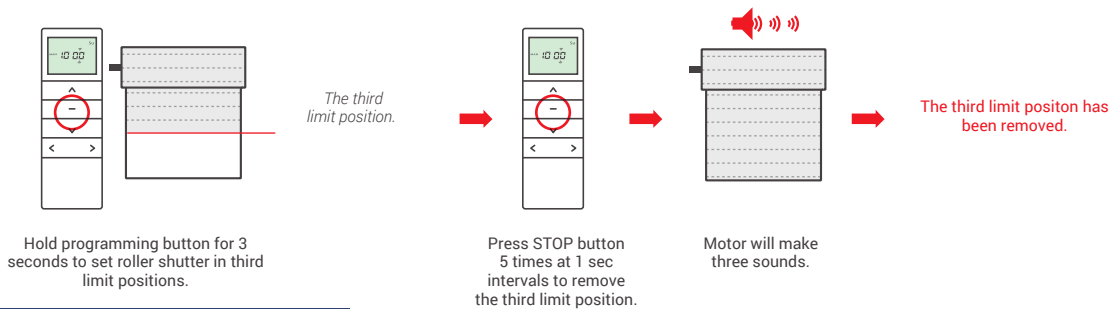

12. Removing limit positions

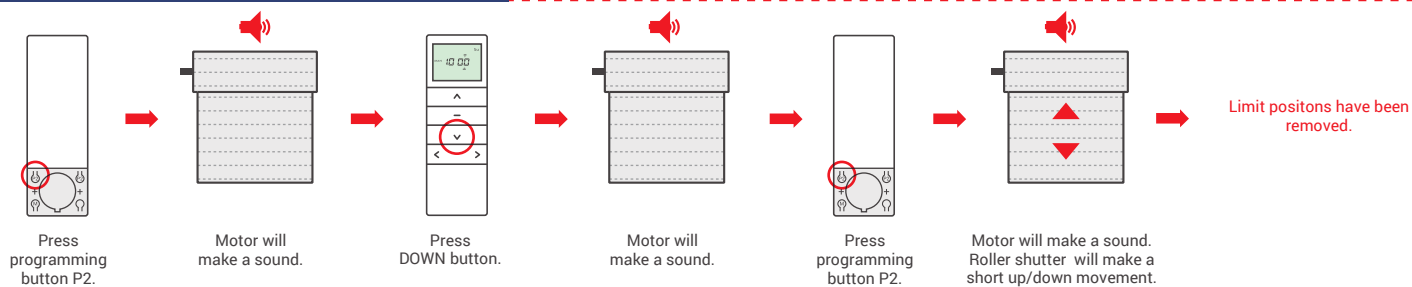

13. Programming another transmitter



1. Receiver can be controlled by up to 20 transmitters.
2. Longer than 4 seconds pause between series of button clicks during programming will cause device to switch off from programming mode without saving any changes.

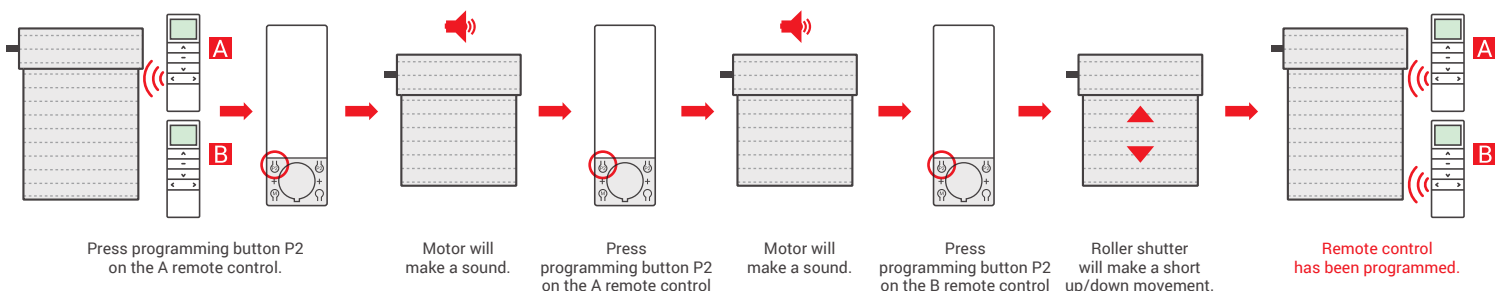

14. Deleting all transmitters



1. Longer than 4 seconds pause between series of button clicks during programming will cause device to switch off from programming mode without saving any changes.
2. Deleting transmitters causes removing limited positions.

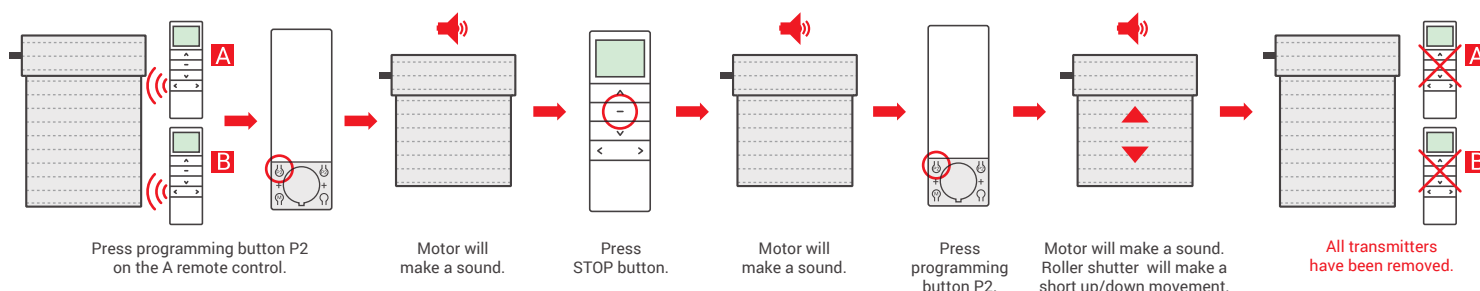

15. Activating impulse mode



1. Longer than 4 seconds pause between series of button clicks during programming will cause device to switch off from programming mode without saving any changes.
2. When the impulse mode is on, pressing the direction button, motor will make a short move.

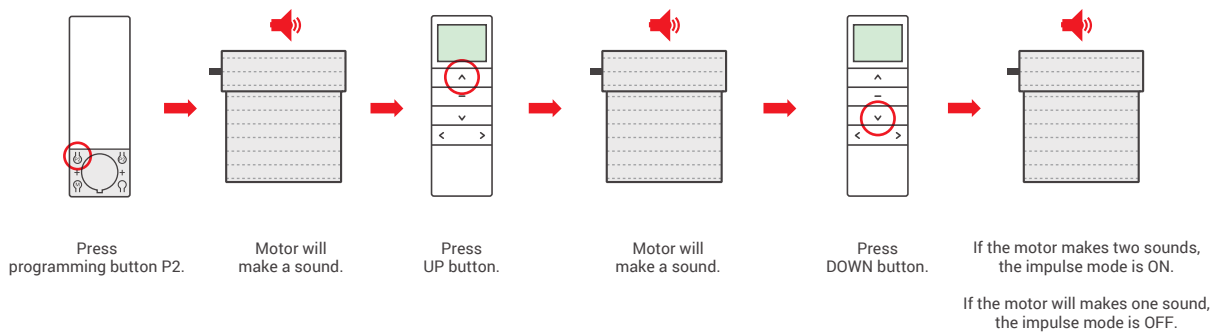

16. Choosing the motor reaction after turning on the power.

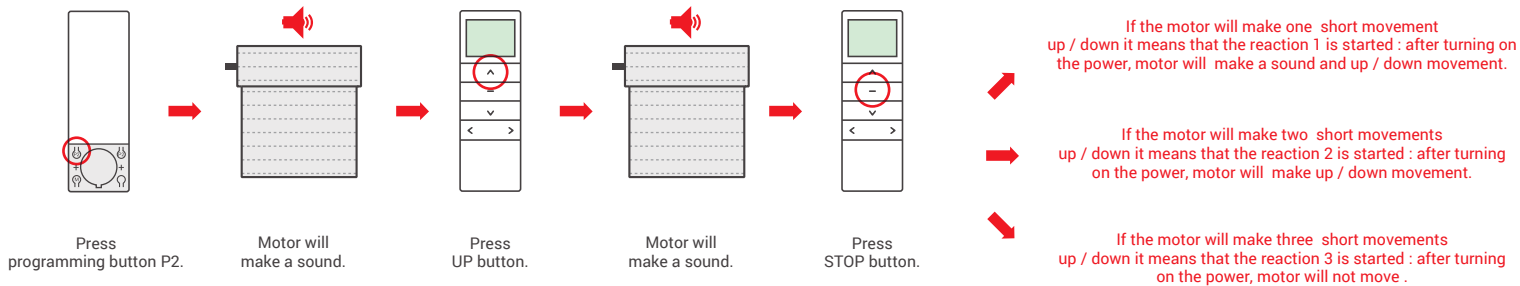

17. Choosing a reaction to obstacle detected

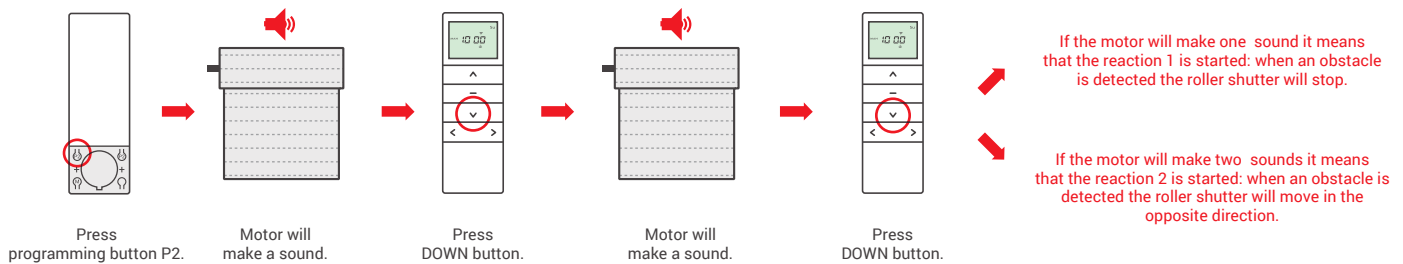

18. Choosing obstacle detected operation mode

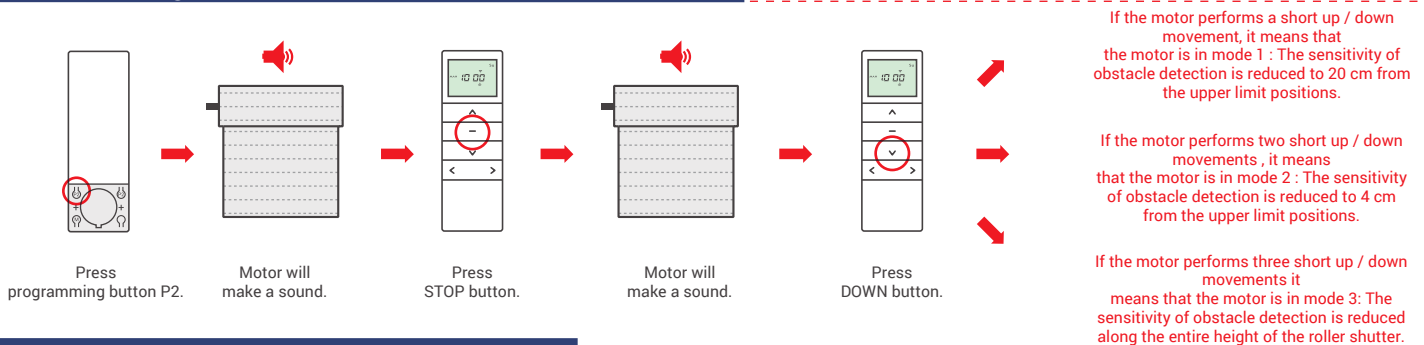

19. Programming key-ring remotes



1. When programming key-ring remotes that do not have additional P2 programming button the same function is substituted with simultaneous push of STOP and UP buttons.
2. Longer than 4 seconds pause between series of button clicks during programming will cause device to switch off from programming mode without saving any changes.

